

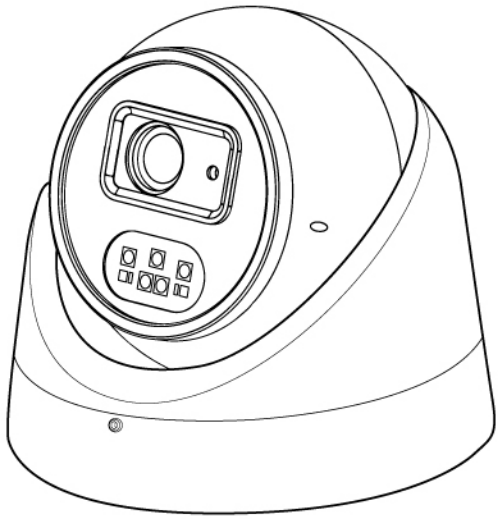

Setup the camera from a computer



Computer system version

- Windows
Requires Windows XP or later
- MAC OS
Requires Mac OS 10.7 or later

Download the CamView user manual here
<http://www.starvedia.com/download.html>



STEP 4 SD Card Recording * Class 10 micro SD is prerequisite

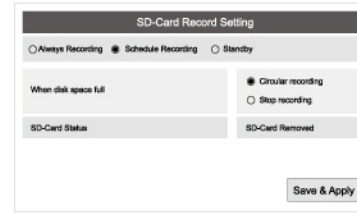

Enable SD card recording.

→ SD Card Record Settings on the Web configuration page. Then select "schedule recording" and the SD card recording will be operational right after saving.

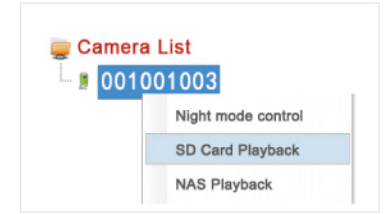

SD Card Playback. Right Click on the selected camera on the camera list, then choose the SD card playback.

STEP 1 Power on the Camera

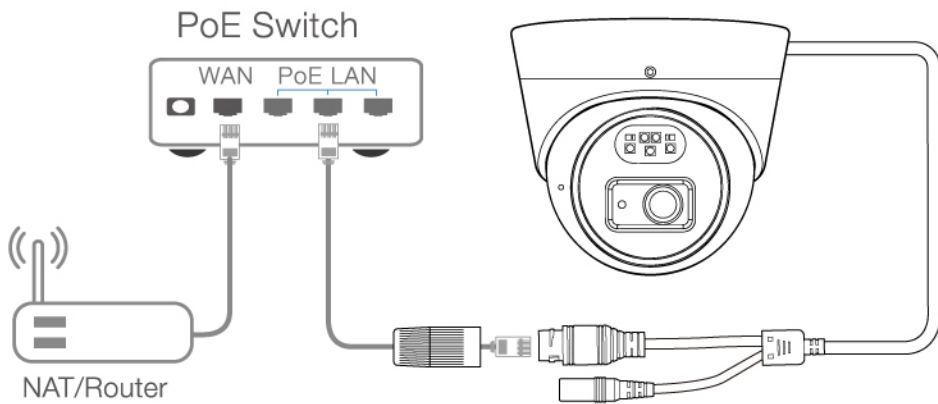

Connect the Camera to the PoE Switch.

STEP 2 Install CamView Software

Please download the latest CamView software at this address :
<http://www.starvedia.com/download.html>

After the setup menu pops up, select "Install Management Software" and follow the instructions.

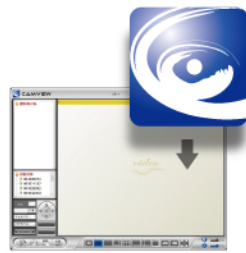

STEP 3 See The Video



The CamView software will list the searched camera on the "Auto search" section. Drag the camera from the "Auto Search" section to the "Camera List" section.

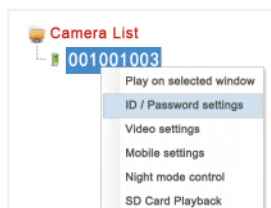

Right click the camera on the camera list and choose the ID/Password Settings.

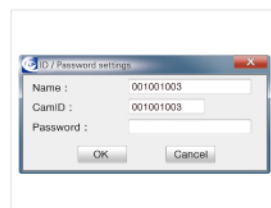

Key-in the password given on the ID/Password Card and then you will be able to see the video.

FAQs

- Q1** What should I do if I have forgotten the password or the ID/Password card is missing?
Ans Please press the Reset button for five seconds. The camera will reset to the factory default settings. The default video-play password is ipcam (lowercase).
- Q2** What should I do if I cannot see the video remotely?
Ans The red LED of the camera should remain on when the camera is connected to the Internet. If the red LED is blinking, please double check the network connection and settings again.
- Q3** I can see the video from a remote location, but the video quality is not satisfying and sometimes the video disconnects and reconnects by itself.
Ans It's probably due to the poor Internet bandwidth (internet speed), which might be not good enough. You may try to apply for a better Internet connection from your Internet Service Provider or reduce the bandwidth setting of the camera.
- Q4** What is the default admin user name/password?
Ans Default admin user name: admin
 Default admin password: _____ (leave blank)
- Q5** Where to download the latest camView software?
Ans Please refer to the following website to download the latest CamView software.
www.starvedia.com/download.html

Package Contents

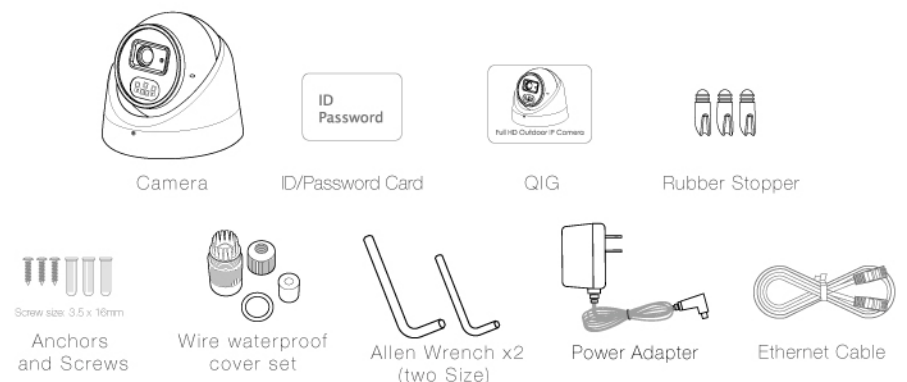

Product View

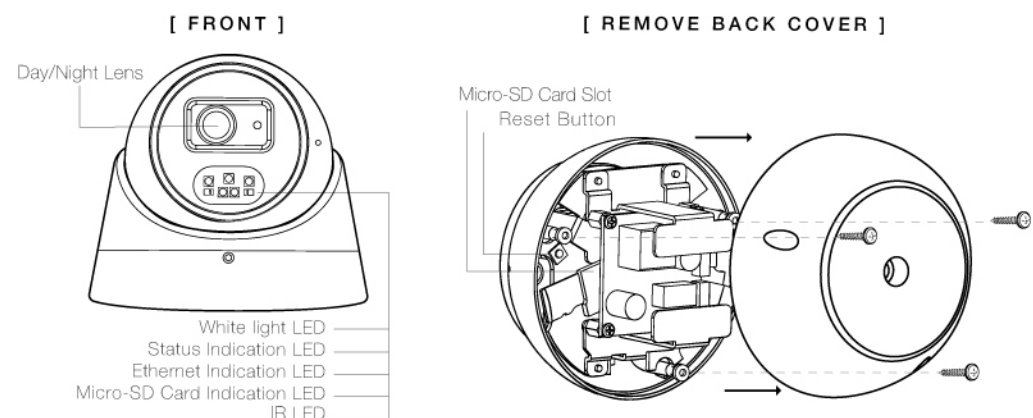

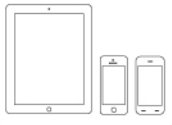

Setup the camera from a Smartphone/Tablet

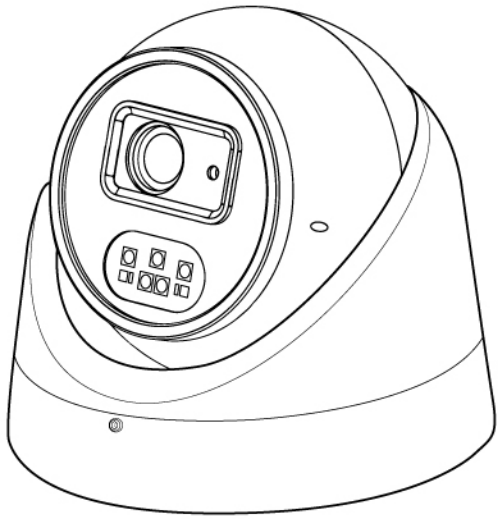

Supported Smart phone system version

- iOS iPhone · iPad
Requires iOS 6.0 or later
- Android Smart phone · Tablet
Requires Android 4.0 or Later

Download the mCamView2 user manual here <http://www.starvedia.com/download.html>

STEP 1 Download the mCamView2 APP



mCamView2

Scan the QR code to download the software “mCamView2” from App Store for iPhone/iPad or from Android Market for Android devices.

STEP 2 Setup

PoE A Connect to the PoE Switch.

B The IP Camera will get an IP address from the Router (with DHCP enabled) automatically. Check if the red LED of the IP camera is always on. If it's blinking, please check step A again

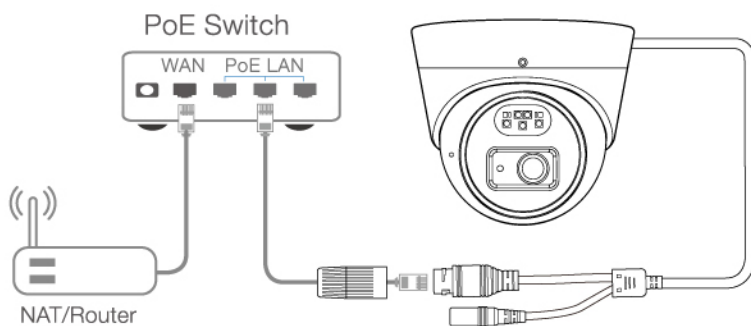

No PoE A Connect to the Router.

B The IP Camera will get an IP address from the Router (with DHCP enabled) automatically. Check if the red LED of the IP camera is always on. If it's blinking, please check step A again

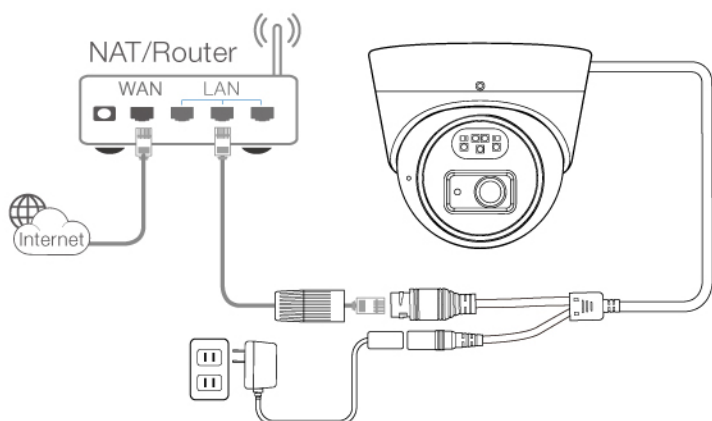

STEP 3 Log in to the Camera

Tap the Camera icon to log in to the camera. The default administration account is “admin”, the default administration password is empty (leave blank).

After logged in, tap the camera icon to play the live video.

Notice : there are two passwords for the camera, one is the administration password, the other one is the video play password. The default video-play password is “ipcam” (lowercase).

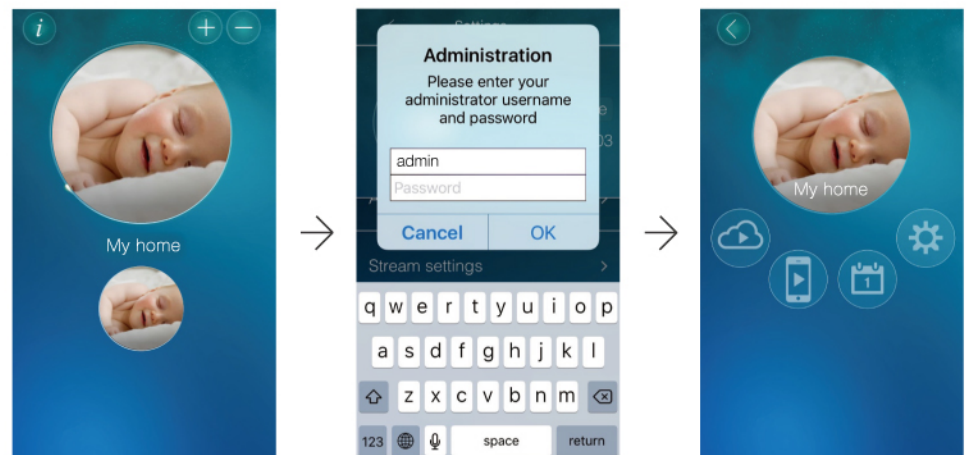

STEP 4 SD Card Recording * Class 10 micro SD is prerequisite

a Insert the SD card into the camera, the yellow LED on the camera will be blinking.

b The SD card will start to do the recording once the alarm notification is triggered. The camera will do 5 second pre-recording to prevent the loss of the important starting moment.

c To enable the continuous SD card recording, please enable it inside the camera settings.

d To playback the recorded video, tap the on the App and choose the “SD Card” and date/time to do the playback.

